

Instructions Manual

Iliaq

2219G.3.Axx

Electric Gynaecology Chair

VERSION 1.25

1. About This Manual

This manual shall only be used for the reference of operation of this particular model. If the manual is used for other purposes, our will not undertake any according consequences and responsibility. . All information of this manual shall be protected by copyright and shall not be copied and translated in any part of this specification without the written consent of our company .

2. Warning

- Power must be cut off when changing electrical components or maintaining and cleaning machines.
- The plug must be plugged into an outlet that is properly installed and grounded, to prevent the risk of fire and electric shock.
- Do not stand on this equipment.
- Do not allow children to play with and place the equipment in a place where children can touch. Please adjust the backrest to the highest position when you leave.
- Please do not place the equipment in wet places such as bathroom to avoid electric shock or other failure; Also keep the controllers away from water.
- Please do not place and operate the equipment in places where is painting/coating or supplying oxygen.
- Unless being monitored or instructed by personnel who can be responsible for their personal safety, the people who have physical obstacles, tactile disorders, mental disorders, lack of experience, common sense or children, are not allowed to use the equipment.
- Please contact distributor, service center or related personal with appropriate skill and experience for repairing if the plug is damaged, in case of any danger.
- Please make sure there is no accessible thing within the stroke during any operation of the products.
- Operation should be processed by trained professionals.
- Original instruction
-  For indoor use only

3. Precautions

- This product should be used by an experienced person who must be familiar with the product structure, performance and instructions. And make the regular maintenance work.
- Read this manual carefully before installation, operation and adjustment. And please keep it well.
- This product shall not be used for single side or single point loading work.
- Comply with safety operation rules, product shall not be overloading, and to ensure that the product safety protection equipment is complete and reliable, eliminates unsafe factors on time.
- Tighten bolts and nuts regularly to avoid failure caused by loose, sliding, vibration and falling off.
- During the maintenance, the operator shall not disassemble any parts of the bed at will.
- This product is not allowed to operate when it's with fault. If abnormal phenomenon or abnormal sound is found, it must be stopped for inspection immediately, and work can be resumed after troubleshooting.
- The operator must be familiar with the precautions described in each section of the manual to ensure the safety of person and product.
- This product is equipped with a three-wire power cord. The power cord must be plugged into a three-hole outlet which is properly installed and grounded. This is not only to prevent the risk of electric shock, but ensure product can work properly.
- Please operate the product strictly accordance with the warning label stamped on it.
- While controlling the lifting , the button must be pressed continuously until the product in a suitable position.
- Please pay attention that the continuous working times should be Max. 2Min. ON ; 18Min. OFF, when operating the motor.
- Maintenance should be processed by trained professionals.
- After every treatment, please only use neutral solution to clear the dust or stains on the product.
- When adjusting each part, please keep your hands, feet and head away from the position indicated by the arrow. (As shown in the photo)

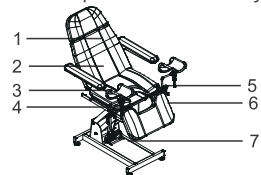

4. Installation

1. Put the product to a proper location, according to the overall layout, the daylighting or artificial lightings and operation condition of the salon's or the home. And keep it in the clean, dry and cool environment.
2. Open the packing carton to check if the product is intact and whether the accessories or spares are complete. Please contact distributor or us if there's any problem.
3. Installation
Place the product to the proper position. Please note that it is unnecessary to install extra screw on the floor to fasten the bed, because the original design has taken the stability into consideration. But please ensure the product is placed on a firm and flat ground, so as to prevent any accident. If the product rotates or slant due to rough ground, please adjust the four pieces of plastic feet (M10×30) and nuts (M10) by hexagon open-end wrench, which are fasten on the bottom panel, so as to ensure the product is stable.
4. Connect the plug of product with power supply properly. (As shown in the photo)

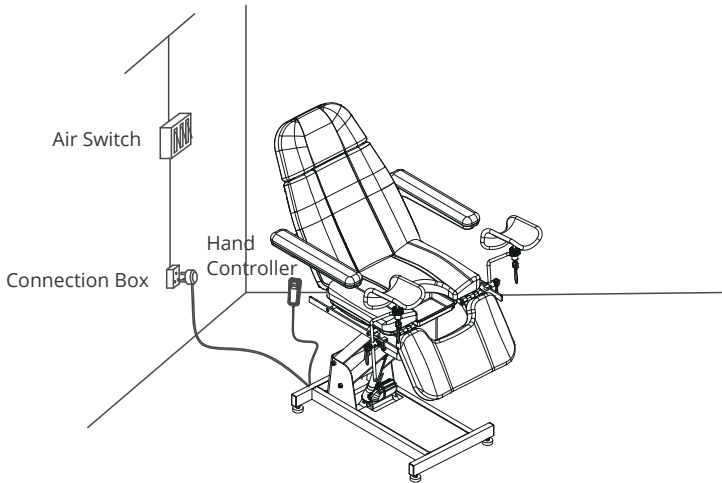

5. Structure of products

- This product consists of control box, motor, hardware, plastic parts and leather. Among them, the control box is controlling the operation of the motors and the hand controller.
- This product includes angle adjustment of the backrest, angle adjustment of the seat cushion and lifting adjustment which is an overall and integral structure. (As shown in the photo)

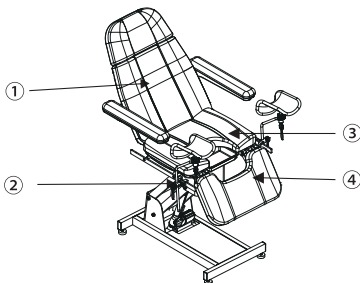

- ① angle adjustment of the backrest
- ② lifting adjustment
- ③ angle adjustment of the seat
- ④ angle adjustment of the footrest (manual adjustment)

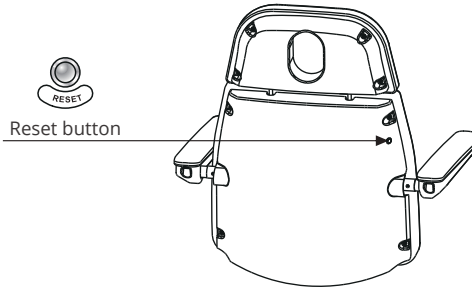

6. Operation Instruction

Standard Configuration

No.	Description	Operation
1	Reset button 	The chair returns to lowest sitting position to allow people to get on and off.

1. Standard Configuration (Hand Controller)

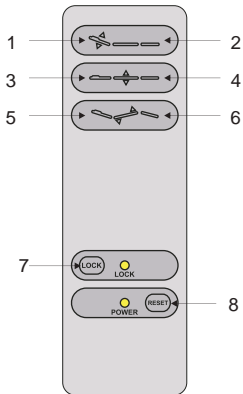

2. Optional Configuration (Foot Controller)

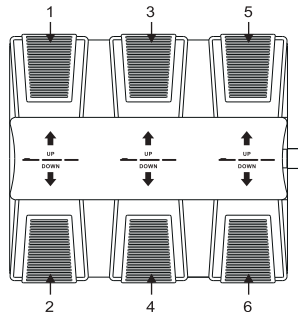

No.	Description	Operation
1	Backrest moves up	Backrest goes up smoothly by pressing the button.
2	Backrest moves down	Backrest goes down smoothly by pressing the button
3	Moves up	Moves up smoothly by pressing the button
4	Moves down	Moves down smoothly by pressing the button
5	Seat cushion up	Seat inclining smoothly by pressing the button
6	Seat cushion down	Seat goes flat smoothly by pressing the button
7	Power indicator	Hand controller are connected with power supply properly, indicator light is on. Otherwise, it won't light.
8	One-key reset button	Press the button, the backrest angle will automatically move to the maximum, the seat cushion angle will automatically reduce to the minimum, footrest angle will automatically move to the maximum, the height of the product will automatically reach the lowest position

7. Technical Parameters

Power	AC 100-120V/AC 220-240V/AC 100-240V, 50/60Hz
Maximum Power	300W
Environment Temperature	0°C~+40°C
Relative Humidity	30%~90%
Lifting Rated Load	175kg
Package Size	1265×785×610mm
Net Weight	92kg
Gross Weight	105kg

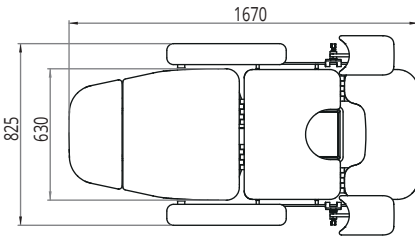
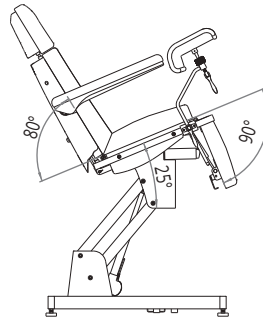
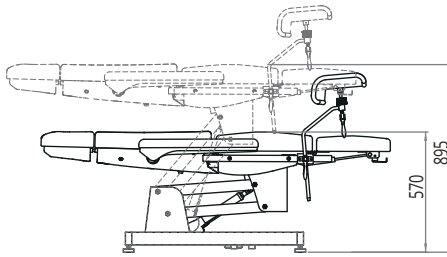

9. Maintenance

1. After every treatment, please only use neutral solution to clear the dust, stains on leather, wooden part, metal part, or other parts. Disinfecting solution like alcohol, acid or alkaline solution are forbidden.
This is to prevent the lifetime of the components from being shortened.
2. Please lubricate the moving parts regularly (once a year)

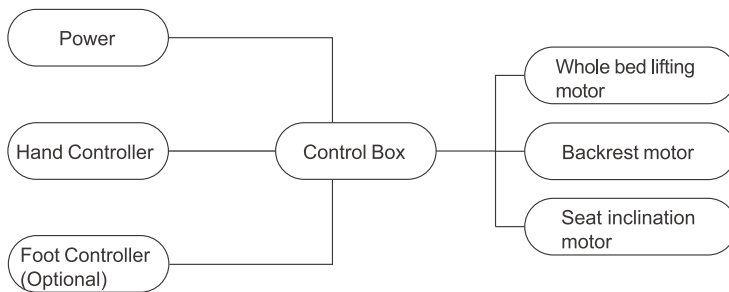

10. Troubleshooting

The Fault Phenomenon	Reason	Solution
motor can't work normally	1. The power cord is unconnected or not plugged well.	1. Connect the power cord or plug it well.
	2. Poor quality of the hand controller or foot controller.	2. Replace the hand controller or foot controller.
	3. Poor quality of the control box.	3. Please contact maintenance center or supplier for troubleshooting.
	4. Repture of motor tail.	
	5. Motor was damaged.	
Abnormal Sound	1. The rotating parts are short of lubricating oil.	1. Add lubricating oil.
	2. Rotating positions (such as hinge, POM sets, gas lift) are short of lubricating oil.	2. Add lubricating oil.
	3. Motor quality problems.	3. Replace the motor.

If problem is still not solved after above operations, please contact maintenance center or supplier to solve it.



Do not dispose of old or defective appliances in domestic garbage; this should only be done through public collection points.

▲ Please check the product specification before use. This manual is for reference only. Specifications are subject to change without prior notice.